

# Oiles Cermet M Sintered bearings with dispersed solid lubricant



## Feature

- Serviceable without the need for lubrication. Demonstrates higher performance when lubricated.
- Demonstrates superior wear resistance in applications where oil film is seldom produced such as reciprocating motions, oscillation, frequent starts and stops, etc.
- Standard products and materials for machining are available in various sizes.

## Service range

Lubrication condition	Dry	periodic lubrication
Service temperature range °C	-40~+200	-40~+150
Allowable max. pressure P N/mm <sup>2</sup> [kgf/cm <sup>2</sup> ]	10 {102}	
Allowable max. velocity V m/s {m/min}	0.85 {51}	1.65 {99}
Allowable max. PV value N/mm <sup>2</sup> · m/s [kgf/cm <sup>2</sup> · m/min]	1.65 {1,010}	2.45 {1,500}

## Mechanical properties

Density	—	g/cm <sup>3</sup>	6.4
Radial crushing strength	JIS Z 2507	N/mm <sup>2</sup> [kgf/mm <sup>2</sup> ]	137 {14}
Hardness	JIS K 7202-2	HRM	73
Oil impregnation rate	—	vol%	3
Co-efficient of linear expansion	—	×10 <sup>-5</sup> °C <sup>-1</sup>	1.9

※The value shown above are for sintered layer.

## Lathe turning

		carbide tool (JIS)	
Cutting tool	Relief angle	2~5°	
	Rake angle	10~20°	
	Nose radius (mm)	0.40~0.80	
Condition	Speed (m/min)	100~120	
	Cut depth (mm)	0.20~0.30	
	Feed (mm/rev)	0.03~0.10	

Apply grease or oil impregnation after machining.

## Machining accuracy (bushing)

I.D.	O.D.	Length
class 7 to 8	class 6 to 7	class 8 to 9

Classes here are in JIS standard.

This product demonstrates satisfactory performance at the slide surface roughness of Rz6.3 to 12.5μm.

## Test data

### Journal rotation test

<Testing conditions>  
 Mating material : S45C  
 Pressure : 1.96N/mm<sup>2</sup> {20.0kgf/cm<sup>2</sup>}  
 Velocity : 0.17m/s {10.0m/min}  
 Test time : 100hrs.  
 Finishing method

..... Test piece after sizing  
 ————— Machined test piece

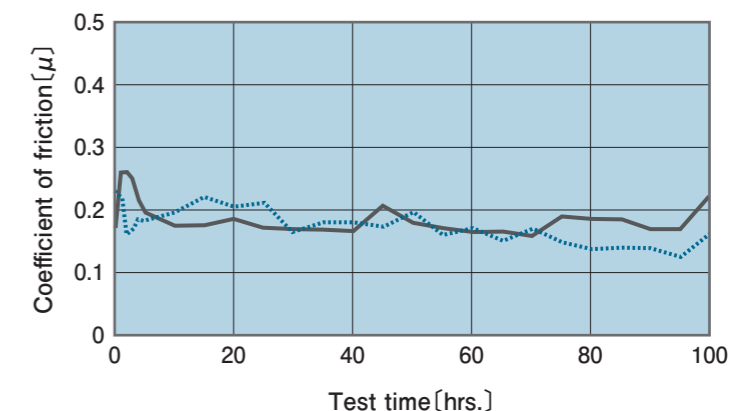
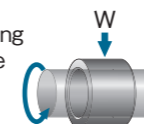

## Oil impregnation method

Oil impregnation is required for oil-containing OILES bearings such as Oiles Cermet M. If you purchase tube or bar stocks, please follow the procedure below to impregnate finished products with lubrication oil before installation. If these bearings are stored for a long time or if the bearings are washed, re-impregnate before installation. Immerse the products into an oil bath. Heat the bath up to 100 °C to 110 °C. Keep the temperature for 30 to 60 minutes until no more air bubbles come up. Cut the heat source and let it cool down to the room temperature. Take products out of the bath to install. If oil impregnation by heating is not possible, leave the products in the oil bath for 24 hours or more.

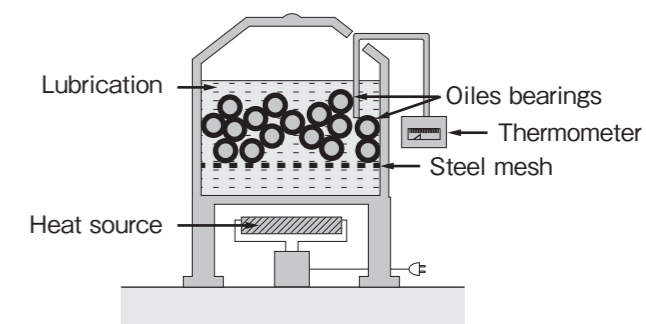

### Selectoin of lubrication oil

Operation conditions	Types of oil	Viscosity	i.e.
Low load / high speed	Lubrication oil of low viscosity	8 to 17cst (30°C)	Spindle oil
Mid load / mid velocity	Lubrication oil with limited viscosity change by temp.	8 to 15cst (98.9°C)	Motor oil
High load / low velocity	Lubrication oil with high viscosity	100 to 1000cst (37°C)	Gear oil

# 54B

## Oiles Cermet M Bushings

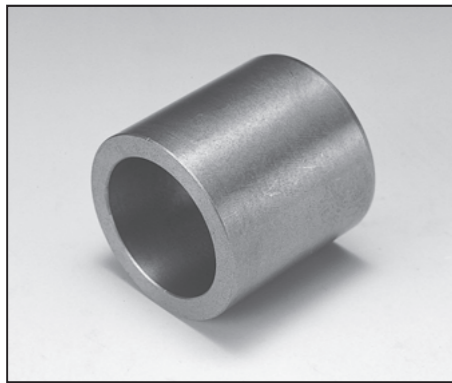

Specify Part No. by required I.D., O.D., and Length.  
(e.g.) I.D. is 12mm, O.D. is 18mm, and length is 10mm.

**54B - 121810**  
Part No.

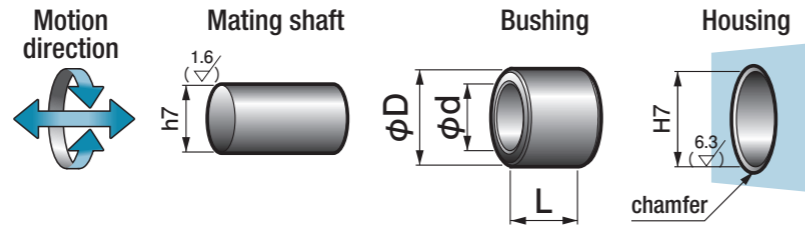

● Some chamfering dimensions may differ from the shown dimension.

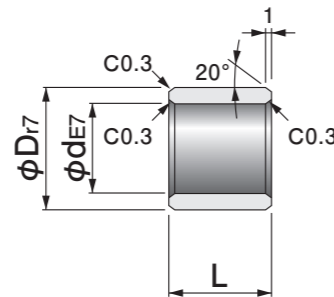
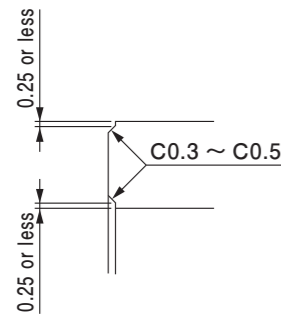

I.D.		O.D.		Length L										Tolerance $\begin{smallmatrix} -0.1 \\ -0.3 \end{smallmatrix}$	I.D. tolerance after press fitting (reference)	
$\phi d$	Tolerance	$\phi D$	Tolerance	3	4	5	6	8	10	15	20	25	30	40		
3	$\begin{smallmatrix} +0.024 \\ +0.014 \end{smallmatrix}$	6	$\begin{smallmatrix} +0.027 \\ +0.015 \end{smallmatrix}$	030603		030605										$\begin{smallmatrix} +0.017 \\ +0.007 \end{smallmatrix}$
4	$\begin{smallmatrix} +0.032 \\ +0.020 \end{smallmatrix}$	7	$\begin{smallmatrix} +0.034 \\ +0.019 \end{smallmatrix}$		040704	040705	040706									$\begin{smallmatrix} +0.023 \\ +0.011 \end{smallmatrix}$
5	$\begin{smallmatrix} +0.032 \\ +0.020 \end{smallmatrix}$	8	$\begin{smallmatrix} +0.034 \\ +0.019 \end{smallmatrix}$			050805	050806	050808								$\begin{smallmatrix} +0.023 \\ +0.011 \end{smallmatrix}$
6	$\begin{smallmatrix} +0.032 \\ +0.020 \end{smallmatrix}$	10	$\begin{smallmatrix} +0.034 \\ +0.019 \end{smallmatrix}$			061005	061006	061008	061010							$\begin{smallmatrix} +0.023 \\ +0.011 \end{smallmatrix}$
8	$\begin{smallmatrix} +0.040 \\ +0.025 \end{smallmatrix}$	12	$\begin{smallmatrix} +0.041 \\ +0.023 \end{smallmatrix}$				081206	081208	081210	081215						$\begin{smallmatrix} +0.029 \\ +0.014 \end{smallmatrix}$
10	$\begin{smallmatrix} +0.040 \\ +0.025 \end{smallmatrix}$	16	$\begin{smallmatrix} +0.041 \\ +0.023 \end{smallmatrix}$				101606	101608	101610	101615	101620					$\begin{smallmatrix} +0.029 \\ +0.014 \end{smallmatrix}$
12	$\begin{smallmatrix} +0.050 \\ +0.032 \end{smallmatrix}$	18	$\begin{smallmatrix} +0.041 \\ +0.023 \end{smallmatrix}$					121808	121810	121815	121820					$\begin{smallmatrix} +0.039 \\ +0.021 \end{smallmatrix}$
14	$\begin{smallmatrix} +0.050 \\ +0.032 \end{smallmatrix}$	20	$\begin{smallmatrix} +0.049 \\ +0.028 \end{smallmatrix}$						142010	142015	142020					$\begin{smallmatrix} +0.036 \\ +0.018 \end{smallmatrix}$
15	$\begin{smallmatrix} +0.050 \\ +0.032 \end{smallmatrix}$	21	$\begin{smallmatrix} +0.049 \\ +0.028 \end{smallmatrix}$						152110	152115	152120	152125				$\begin{smallmatrix} +0.036 \\ +0.018 \end{smallmatrix}$
16	$\begin{smallmatrix} +0.050 \\ +0.032 \end{smallmatrix}$	22	$\begin{smallmatrix} +0.049 \\ +0.028 \end{smallmatrix}$						162210	162215	162220	162225				$\begin{smallmatrix} +0.036 \\ +0.018 \end{smallmatrix}$
18	$\begin{smallmatrix} +0.050 \\ +0.032 \end{smallmatrix}$	24	$\begin{smallmatrix} +0.049 \\ +0.028 \end{smallmatrix}$						182410	182415	182420	182425	182430			$\begin{smallmatrix} +0.036 \\ +0.018 \end{smallmatrix}$
20	$\begin{smallmatrix} +0.061 \\ +0.040 \end{smallmatrix}$	28	$\begin{smallmatrix} +0.049 \\ +0.028 \end{smallmatrix}$							202815	202820		202830			$\begin{smallmatrix} +0.047 \\ +0.026 \end{smallmatrix}$
25	$\begin{smallmatrix} +0.061 \\ +0.040 \end{smallmatrix}$	35	$\begin{smallmatrix} +0.059 \\ +0.034 \end{smallmatrix}$								253520	253525	253530			$\begin{smallmatrix} +0.044 \\ +0.018 \end{smallmatrix}$
30	$\begin{smallmatrix} +0.061 \\ +0.040 \end{smallmatrix}$	40	$\begin{smallmatrix} +0.059 \\ +0.034 \end{smallmatrix}$									304020	304025	304030	304040	$\begin{smallmatrix} +0.044 \\ +0.018 \end{smallmatrix}$

※The I.D. tolerance after press fitting is for reference only.

▲ The dimensional tolerances are the values measured at +25°C.

# 54F

## Oiles Cermet M Flange Bushings

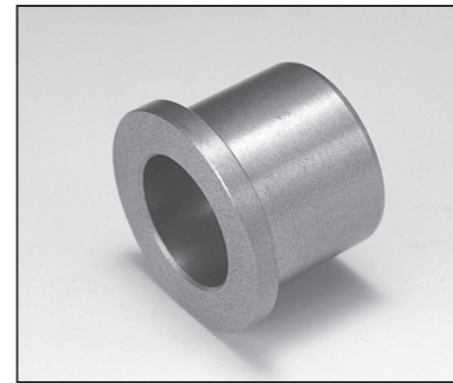

Specify Part No. by required I.D. and Length.  
(e.g.) I.D. is 12mm and length is 12mm.

**54F - 1212**  
Part No.

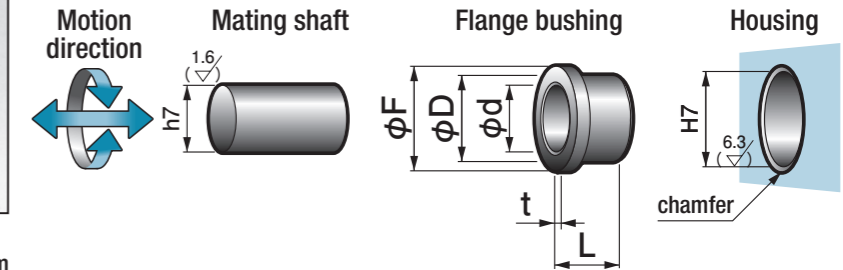

● Some chamfering dimensions may differ from the shown dimension.

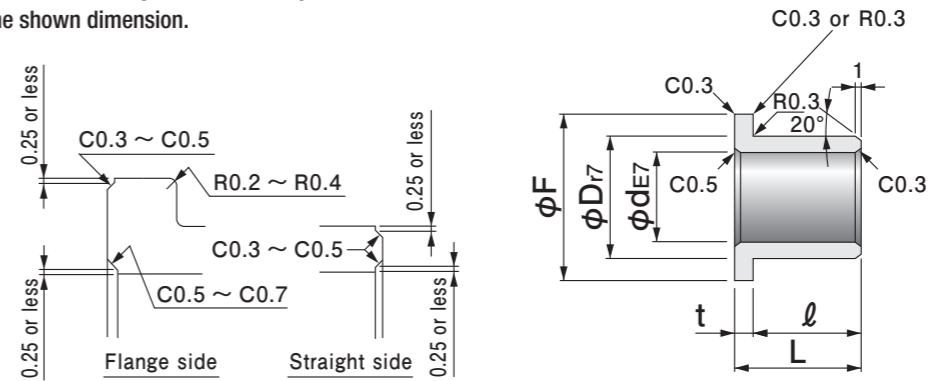

Part No.	I.D.		O.D.		Flange			Length		I.D. tolerance after press fitting (reference)		
	$\phi d$	Tolerance	$\phi D$	Tolerance	$\phi F$	Tolerance	t	Tolerance	L		Tolerance	$\ell$
54F-0303	3	$\begin{smallmatrix} +0.024 \\ +0.014 \end{smallmatrix}$	6	$\begin{smallmatrix} +0.027 \\ +0.015 \end{smallmatrix}$	9	$\begin{smallmatrix} 0 \\ -0.2 \end{smallmatrix}$	1.5	$\begin{smallmatrix} 0 \\ -0.2 \end{smallmatrix}$	4.5	$\begin{smallmatrix} 0 \\ -0.4 \end{smallmatrix}$	3	$\begin{smallmatrix} +0.017 \\ +0.007 \end{smallmatrix}$
54F-0404	4	$\begin{smallmatrix} +0.032 \\ +0.020 \end{smallmatrix}$	7	$\begin{smallmatrix} +0.034 \\ +0.019 \end{smallmatrix}$	10	$\begin{smallmatrix} 0 \\ -0.2 \end{smallmatrix}$	1.5	$\begin{smallmatrix} 0 \\ -0.2 \end{smallmatrix}$	5.5	$\begin{smallmatrix} 0 \\ -0.4 \end{smallmatrix}$	4	$\begin{smallmatrix} +0.023 \\ +0.011 \end{smallmatrix}$
54F-0505	5	$\begin{smallmatrix} +0.032 \\ +0.020 \end{smallmatrix}$	8	$\begin{smallmatrix} +0.034 \\ +0.019 \end{smallmatrix}$	11	$\begin{smallmatrix} 0 \\ -0.2 \end{smallmatrix}$	1.5	$\begin{smallmatrix} 0 \\ -0.2 \end{smallmatrix}$	6.5	$\begin{smallmatrix} 0 \\ -0.4 \end{smallmatrix}$	5	$\begin{smallmatrix} +0.023 \\ +0.011 \end{smallmatrix}$
54F-0606	6	$\begin{smallmatrix} +0.032 \\ +0.020 \end{smallmatrix}$	10	$\begin{smallmatrix} +0.034 \\ +0.019 \end{smallmatrix}$	14	$\begin{smallmatrix} 0 \\ -0.2 \end{smallmatrix}$	2	$\begin{smallmatrix} 0 \\ -0.2 \end{smallmatrix}$	8	$\begin{smallmatrix} 0 \\ -0.4 \end{smallmatrix}$	6	$\begin{smallmatrix} +0.023 \\ +0.011 \end{smallmatrix}$
54F-0808	8	$\begin{smallmatrix} +0.040 \\ +0.025 \end{smallmatrix}$	12	$\begin{smallmatrix} +0.041 \\ +0.023 \end{smallmatrix}$	16	$\begin{smallmatrix} 0 \\ -0.2 \end{smallmatrix}$	2	$\begin{smallmatrix} 0 \\ -0.2 \end{smallmatrix}$	10	$\begin{smallmatrix} 0 \\ -0.4 \end{smallmatrix}$	8	$\begin{smallmatrix} +0.029 \\ +0.014 \end{smallmatrix}$
54F-1010	10	$\begin{smallmatrix} +0.040 \\ +0.025 \end{smallmatrix}$	16	$\begin{smallmatrix} +0.041 \\ +0.023 \end{smallmatrix}$	20	$\begin{smallmatrix} 0 \\ -0.2 \end{smallmatrix}$	2	$\begin{smallmatrix} 0 \\ -0.2 \end{smallmatrix}$	12	$\begin{smallmatrix} 0 \\ -0.4 \end{smallmatrix}$	10	$\begin{smallmatrix} +0.029 \\ +0.014 \end{smallmatrix}$
54F-1212	12	$\begin{smallmatrix} +0.050 \\ +0.032 \end{smallmatrix}$	18	$\begin{smallmatrix} +0.041 \\ +0.023 \end{smallmatrix}$	22	$\begin{smallmatrix} 0 \\ -0.2 \end{smallmatrix}$	2	$\begin{smallmatrix} 0 \\ -0.2 \end{smallmatrix}$	14	$\begin{smallmatrix} 0 \\ -0.4 \end{smallmatrix}$	12	$\begin{smallmatrix} +0.039 \\ +0.021 \end{smallmatrix}$
54F-1414	14	$\begin{smallmatrix} +0.050 \\ +0.032 \end{smallmatrix}$	20	$\begin{smallmatrix} +0.049 \\ +0.028 \end{smallmatrix}$	24	$\begin{smallmatrix} 0 \\ -0.2 \end{smallmatrix}$	3	$\begin{smallmatrix} 0 \\ -0.2 \end{smallmatrix}$	17	$\begin{smallmatrix} 0 \\ -0.4 \end{smallmatrix}$	14	$\begin{smallmatrix} +0.036 \\ +0.018 \end{smallmatrix}$
54F-1515	15	$\begin{smallmatrix} +0.050 \\ +0.032 \end{smallmatrix}$	21	$\begin{smallmatrix} +0.049 \\ +0.028 \end{smallmatrix}$	27	$\begin{smallmatrix} 0 \\ -0.2 \end{smallmatrix}$	3	$\begin{smallmatrix} 0 \\ -0.2 \end{smallmatrix}$	18	$\begin{smallmatrix} 0 \\ -0.4 \end{smallmatrix}$	15	$\begin{smallmatrix} +0.036 \\ +0.018 \end{smallmatrix}$
54F-1616	16	$\begin{smallmatrix} +0.050 \\ +0.032 \end{smallmatrix}$	22	$\begin{smallmatrix} +0.049 \\ +0.028 \end{smallmatrix}$	28	$\begin{smallmatrix} 0 \\ -0.2 \end{smallmatrix}$	3	$\begin{smallmatrix} 0 \\ -0.2 \end{smallmatrix}$	19	$\begin{smallmatrix} 0 \\ -0.4 \end{smallmatrix}$	16	$\begin{smallmatrix} +0.036 \\ +0.018 \end{smallmatrix}$
54F-1817	18	$\begin{smallmatrix} +0.050 \\ +0.032 \end{smallmatrix}$	24	$\begin{smallmatrix} +0.049 \\ +0.028 \end{smallmatrix}$	30	$\begin{smallmatrix} 0 \\ -0.2 \end{smallmatrix}$	3	$\begin{smallmatrix} 0 \\ -0.2 \end{smallmatrix}$	20	$\begin{smallmatrix} 0 \\ -0.4 \end{smallmatrix}$	17	$\begin{smallmatrix} +0.036 \\ +0.018 \end{smallmatrix}$
54F-2021	20	$\begin{smallmatrix} +0.061 \\ +0.040 \end{smallmatrix}$	28	$\begin{smallmatrix} +0.049 \\ +0.028 \end{smallmatrix}$	34	$\begin{smallmatrix} 0 \\ -0.2 \end{smallmatrix}$	4	$\begin{smallmatrix} 0 \\ -0.2 \end{smallmatrix}$	25	$\begin{smallmatrix} 0 \\ -0.4 \end{smallmatrix}$	21	$\begin{smallmatrix} +0.047 \\ +0.026 \end{smallmatrix}$
54F-2521	25	$\begin{smallmatrix} +0.061 \\ +0.040 \end{smallmatrix}$	35	$\begin{smallmatrix} +0.059 \\ +0.034 \end{smallmatrix}$	42	$\begin{smallmatrix} 0 \\ -0.2 \end{smallmatrix}$	4	$\begin{smallmatrix} 0 \\ -0.2 \end{smallmatrix}$	25	$\begin{smallmatrix} 0 \\ -0.4 \end{smallmatrix}$	21	$\begin{smallmatrix} +0.044 \\ +0.023 \end{smallmatrix}$
54F-3026	30	$\begin{smallmatrix} +0.061 \\ +0.040 \end{smallmatrix}$	40	$\begin{smallmatrix} +0.059 \\ +0.034 \end{smallmatrix}$	48	$\begin{smallmatrix} 0 \\ -0.2 \end{smallmatrix}$	4	$\begin{smallmatrix} 0 \\ -0.2 \end{smallmatrix}$	30	$\begin{smallmatrix} 0 \\ -0.4 \end{smallmatrix}$	26	$\begin{smallmatrix} +0.044 \\ +0.023 \end{smallmatrix}$

※The I.D. tolerance after press fitting is for reference only.

▲ The dimensional tolerances are the values measured at +25°C.

# 54M Oiles Cermet M Bar Stock

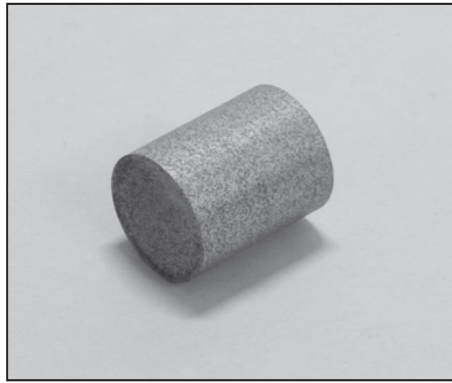

Specify Part No. by required diameter and length.  
(e.g.) Diameter is 21mm and length is 26mm.

**54M - 2126**  
Part No.

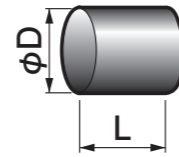

● Oil impregnation is necessary by referring to the oil impregnation method, page 250 when you machined the plate.

Part No.	Diameter		Length	
	$\phi D$	Tolerance	L	Tolerance
<b>54M-0910</b>	9	$+0.6$ $+0.2$	10	$+3.0$ $0$
<b>54M-1316</b>	13	$+0.6$ $-0.2$	16	$+3.0$ $0$
<b>54M-1821</b>	18	$+0.6$ $-0.2$	21	$+3.0$ $0$
<b>54M-2126</b>	21	$+0.8$ $0$	26	$+3.0$ $0$
<b>54M-2631</b>	26	$+0.8$ $0$	31	$+3.0$ $0$
<b>54M-3341</b>	33	$+0.8$ $0$	41	$+3.0$ $0$
<b>54M-4146</b>	41	$+0.8$ $0$	46	$+3.0$ $0$
<b>54M-6049</b>	60	$+2.0$ $+1.0$	49	$+3.0$ $0$

# 54S Oiles Cermet M Bushing Material

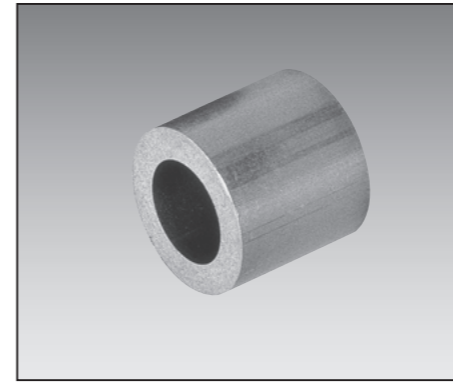

Specify Part No. by required I.D., O.D., and Length.  
(e.g.) I.D. is 12mm, O.D. is 18mm, and length is 10mm.

**54S - 153131**  
Part No.

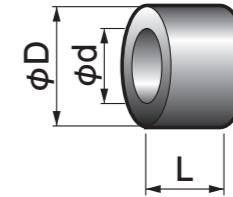

● Oil impregnation is necessary by referring to the oil impregnation method, page 250 when you machined the plate.

Part No.	I.D.		O.D.		Length	
	$\phi d$	Tolerance	$\phi D$	Tolerance	L	Tolerance
<b>54S-092333</b>	9	$+0.5$ $-0.3$	23	$+0.6$ $-0.2$	33	$+3.0$ $0$
<b>54S-142631</b>	14	$+0.5$ $-0.3$	26	$+0.8$ $0$	31	$+3.0$ $0$
<b>54S-153131</b>	15	$+0.5$ $-0.3$	31	$+0.6$ $-0.2$	31	$+3.0$ $0$
<b>54S-244133</b>	24	$+0.5$ $-0.3$	41	$+0.8$ $0$	33	$+3.0$ $0$
<b>54S-294136</b>	29	$+0.5$ $-0.3$	41	$+0.8$ $0$	36	$+3.0$ $0$
<b>54S-294933</b>	29	$+0.5$ $-0.3$	49	$+0.6$ $-0.2$	33	$+3.0$ $0$

Selection Guide

Product Information

Plastic Bearing

Multi-layer Bearing

Metallic Bearing

Air Bearings

Slide Shifter

Technical Information

Corporate Profile

Selection Guide

Product Information

Plastic Bearing

Multi-layer Bearing

Metallic Bearing

Air Bearings

Slide Shifter

Technical Information

Corporate Profile